

Hedde Zeijlstra
University of Goettingen
heddezeijlstra.org

Joint work with Stefan Keine (UCLA)

1. Introduction

- According to standard phase theory (Chomsky 2000, 2001, 2008), syntactic structure is subject to period Spell-Out (or Transfer), which renders it unavailable for further syntactic processes (the Phase Impenetrability Condition or PIC)
- The traditional view (Chomsky 2000, 2001 and much subsequent work) holds that CPs and (transitive) vPs are phases, at least in the verbal domain, but more recently a number of alternatives has been explored in the literature, including that every phrase is a phase (Bošković 2002, Boeckx 2003, Müller 2004, 2010, 2011, Boeckx and Grohmann 2007; see also Manzini 1994 and Takahashi 1994), that every syntactic operation constitutes a phase (Epstein and Seely 2002), that phasehood is determined contextually (Bošković 2005, 2014, Den Dikken 2007, Gallego and Uriagereka 2007a,b, Takahashi 2010, 2011), and that CP is a phase but vP is not (Keine 2016, 2020a,b, Grano and Lasnik 2018).
- Across these proposals, there is broad (though not universal, see Den Dikken 2017) consensus that CP is a phase, a view that goes back to Chomsky (1973, 1977, 1981). But the identity and distribution of other phases, most notably vP, is less securely established and hence more controversial.
- In this paper, we focus on the status of vP as a phase. The literature has presented a number of strong arguments that vP is a phase alongside CP (e.g., that both may be the landing site of successive-cyclic movement; see Abels 2012, Citko 2014, Georgi 2014, Van Urk 2020a,c, among others).
- At the same time, the recent literature documents striking locality asymmetries between CPs and vPs, which remain unaccounted for if CPs and vPs are on par as locality domains qua phases. Interestingly, all of these asymmetries have in common that CP constitutes a locality domain for some syntactic process, but vP does not.
- The crucial question we face, then, is how to reconcile these arguments with the CP–vP asymmetries we observe in other domains. That is the goal of this talk.

2. Asymmetries between CPs and vPs

- Treating vPs as phases alongside CPs leads to the expectation that vPs have the same phase locality effect as CPs. There is a growing body of evidence that this is not the case, in that CPs exhibit certain locality effects that vPs systematically lack. To the extent that these locality effects are the result of phases, such differences cast doubt on the view that CPs and vPs are parallel in their phasal status.

2.1 Locality of ϕ -agreement:

- Polinsky ((2003) and Bobaljik (2008) identify a generalization for long-distance agreement (LDA). According to this generalization, LDA may target the edge of an embedded CP clause but not material that is more deeply embedded (see Bruening 2001, Polinsky and Potsdam 2001, Branigan and MacKenzie 2002).
- This is very plausibly a CP-phase effect. Once the matrix ϕ -probe enters the structure, only the edge of the embedded clause is accessible, imposing a principled limit on the distance of LDA (see (1)).
- Keine (2020b) reasons that if vP is a phase, we expect it to likewise limit LDA to its edge. Based on evidence from Hindi-Urdu, Keine (2020b) argues that this is not the case. Instead, we find ϕ -agreement that crosses an arbitrary number of vPs (but still cannot cross a CP), for instance in Hindi (3), as schematized in (2).

(1) [T_[u ϕ] ... [CP (DP_[ϕ]) [TP ... (DP_[ϕ]) ...]]]

(2) [T_[u ϕ] ... [vP ... [vP ... [vP ... DP_[ϕ] ...]]]]]

(3) ?Ram-ne [_{vP} [_{vP} Pratap-kii khuub marammat kar-nii] shuruu kar-nii]
 Ram-ERG Pratap-GEN lot repair.F.SG do-INF.F.SG start do-INF.F.SG
 caah-ii.
 want-PFV.F.SG
 'Ram wanted to start giving Pratap a good beating.' (*lit.* 'Ram wanted to start doing
 Pratap's many repairs.') [Keine 2020b:277, ex. (437)]

2.2 Negative Concord

- Negative Concord cannot cross a CP boundary but they may cross a vP (Zeijlstra 2004, 2012) and licensing of strong NPIs (see Giannakidou and Zeijlstra 2017 and the references therein), as shown below.

(4) a. Gianni non ha [_{vP} telefonato a nessuno].
 Gianni NEG has called to nobody
 'Gianni didn't call anybody.' [Zeijlstra 2004:130, ex. (50a)]

b. *Gianni non ha detto [_{CP} che ha telefonato a nessuno].
 Gianni NEG has said that has called to nobody
 'Gianni didn't say that he called anybody.' [Zeijlstra 2012:520, ex. (53)]

(5) a. Mary didn't [_{vP} talk to any student at all].
 b. *Mary didn't say [_{CP} that they talked to any student at all].

2.3 Locality of dependent-case assignment

- Poole (2020) argues that dependent-case assignment may not cross a CP but that it may

cross a vP. This asymmetry again follows if CP is a phase, but vP is not (Poole 2020:40–41).

2.4 *Intermediate gaps in sentence processing*

- Gibson and Warren (2004) argue that intermediate landing sites created by successive cyclicity facilitate filler retrieval in online sentence processing. Keine (2020a) compares the effect of crossing a CP and of crossing a vP on such facilitation. He finds that while crossing a CP facilitates filler retrieval, crossing a vP does not.

3. Evidence that v is a phase

- The rich literature on vP-phasality contains a substantial number of arguments for vP phases. In this talk, we focus in particular on three arguments: *ké*-morphology in Dinka; (b) *meN*-deletion in Indonesian; and (c) *kè*-morphology in Defaka. All three arguments have been taken as clear evidence that elements that are extracted out of a vP must pass through [Spec,vP], and hence as evidence for vP phases.
- The arguments from morphological reflexes seem to us to be particularly compelling. As Keine (2020b) points out, other arguments are less convincing because they involve an optional phenomenon. In a nutshell, these phenomena establish that it is possible for a movement to pass through an intermediate landing site in the vP region. While this is compatible with vP phases, it does not require vP phases and as such it does not constitute direct evidence that vP is a phase.

3.1 *ké-morphology in Dinka*

- [Spec,vP] and vP phasehood is developed for the Nilotic language Dinka by Van Urk (2015, 2018) and Van Urk and Richards (2015). The argument is two-pronged. First, extraction has an empty-position effect within the vP; second, such extraction leads to the appearance of the special marker *ké* in the vP region. The two aspects of the argument are interrelated, and we will present them in turn.
- As illustrated in (9), Dinka is a V2 language, with exactly one constituent preceding a verbal element in the second position of the clause.

- (9) a. *Áyén à-càm cuḷin nẹ pǎal.*
 Ayen 3P-eat food P knife
 ‘Ayen is eating food with a knife.’
- b. *Cuḷin à-cḗem Áyèn nẹ pǎal.*
 food 3P-eat.OV Ayen.GEN P knife
 ‘Food, Ayen is eating with the knife.’
- c. *Pǎal à-cḗemè Áyèn cuḷin.*
 knife 3P-eat.OBLV Ayen.GEN food
 ‘With a knife, Ayen is eating food.’

[Van Urk 2018:942, ex. (6a–c)]

- Turning to the Dinka vP, Van Urk (2015, 2018) and Van Urk and Richards (2015) argue that here too we find a V2 property such that exactly one constituent precedes the verb in the vP. For example, in a transitive clause, the object must occur in a preverbal

position, as shown in (10).

- (10) a. $\Upsilon\acute{\epsilon}\epsilon\text{n}$ $\text{c}\acute{\epsilon}$ miir $\text{t}\grave{\text{i}}\eta$.
 I PFV giraffe see
 'I saw a giraffe.'
- b. * $\Upsilon\acute{\epsilon}\epsilon\text{n}$ $\text{c}\acute{\epsilon}$ _____ $\text{t}\grave{\text{i}}\eta$ miir.
 I PFV see giraffe
 'I saw a giraffe.' [Van Urk and Richards 2015:122, ex. (14a,b)]

- If the vP is ditransitive, one of the two objects must occupy the preverbal position, as (11a–b) illustrates. It is not possible for both objects to occur postverbally (11c–d), nor is it possible for both objects to occur preverbally (11e–f).

- (11) a. $\Upsilon\acute{\epsilon}\epsilon\text{n}$ $\text{c}\acute{\epsilon}$ Ayén $\text{y}\grave{\text{i}}\eta\text{n}$ kitáp.
 I PFV Ayen give book
- b. $\Upsilon\acute{\epsilon}\epsilon\text{n}$ $\text{c}\acute{\epsilon}$ kitáp $\text{y}\grave{\text{i}}\eta\text{n}$ Ayén.
 I PFV book give Ayen [Van Urk and Richards 2015:122, ex. (15a,b)]
- c. * $\Upsilon\acute{\epsilon}\epsilon\text{n}$ $\text{c}\acute{\epsilon}$ _____ $\text{y}\grave{\text{i}}\eta\text{n}$ kitáp Ayén.
 I PFV give book Ayen
- d. * $\Upsilon\acute{\epsilon}\epsilon\text{n}$ $\text{c}\acute{\epsilon}$ _____ $\text{y}\grave{\text{i}}\eta\text{n}$ Ayén kitáp.
 I PFV give Ayen book [Van Urk and Richards 2015:122–123, ex. (16a,b)]
- e. * $\Upsilon\acute{\epsilon}\epsilon\text{n}$ $\text{c}\acute{\epsilon}$ kitáp Ayén $\text{y}\grave{\text{i}}\eta\text{n}$.
 I PFV book Ayen give
- f. * $\Upsilon\acute{\epsilon}\epsilon\text{n}$ $\text{c}\acute{\epsilon}$ Ayén kitáp $\text{y}\grave{\text{i}}\eta\text{n}$.
 I PFV Ayen book give
 'I gave Ayen a book.' [Van Urk and Richards 2015:122n11, ex. (i.a,b)]

- Van Urk (2015, 2018) and Van Urk and Richards (2015) analyze this preverbal position as [Spec,vP], though we will diverge from this view in our own analysis.
- If there is a movement dependency, every [Spec,CP] and preverbal position along the movement path must be empty. This is shown for [Spec,CP] in (13) and for the preverbal position in (14). As (14a) shows, it is possible for movement to target the preverbal object in a ditransitive configuration (whether it is a direct or indirect object). By contrast, (14b) shows that it is not possible to move the postverbal DP.

- (13) a. $\text{Y}\acute{\epsilon}\eta\grave{\text{a}}$ $\text{c}\acute{\text{u}}\eta\text{k}\eta\grave{\text{u}}$ $\text{l}\acute{\text{u}}\acute{\epsilon}\acute{\epsilon}\text{l}$, [_{CP} _____ $\text{c}\acute{\epsilon}$ kitáp $\text{y}\grave{\text{o}}\text{o}\text{c}$]?
 who PFV.1PL say PFV book buy.TR
 'Who did we say bought a book?'
- b. * $\text{Y}\acute{\epsilon}\eta\grave{\text{a}}$ $\text{c}\acute{\text{u}}\eta\text{k}\eta\grave{\text{u}}$ $\text{l}\acute{\text{u}}\acute{\epsilon}\acute{\epsilon}\text{l}$, [_{CP} kitáp (à-)c $\acute{\text{i}}$ $\text{y}\grave{\text{o}}\text{o}\text{c}$]?
 who PFV.1PL say book 3SG-PFV.NSV buy.TR
 'Who did we say bought a book?' [Van Urk and Richards 2015:125, ex. (21a,b)]

- (14) a. Yerà c̄i m̄oc _____ yīen kitáp?
 who PFV.NSV man.GEN give book
- b. *Yerà c̄i m̄oc kitáp yīen?
 who PFV.NSV man.GEN book give
 ‘Who did the man give the book to?’ [Van Urk and Richards 2015:125, ex. (20a,b)]

- Van Urk (2015, 2018) and Van Urk and Richards (2015) analyze both effects in terms of phases. (13) follows from CP phases. And based on the analysis of the preverbal position as [Spec,vP], (14) is attributed to vP phases: only an object that has shifted to [Spec,vP] is accessible for further movement to [Spec,CP]. One-fell-swoop extraction as in (14b) is therefore ruled out.

- As investigated in detail by Van Urk (2015), Van Urk and Richards (2015), and in particular Van Urk (2018), in addition to this empty-position effect, A-extraction out of vP in Dinka yields special morphology, as we now discuss. Whenever a plural element is moved out of vP in Dinka except for local subjects, the element *ké* (or *kêek*) must appear next to every verb that is crossed by the movement. This element is homophonous with (and, depending on the analysis, identical to) the 3rd person plural personal pronoun. The appearance of *ké* is illustrated in (15), where A-movement of *yeyínà* ‘who.pl’ and *kêek* ‘them’ requires a preverbal *ké*, which is impossible in the absence of such movement.

(15) *Object \bar{A} -movement triggers ké*

- a. Yeyínà c̄i Ból ké t̄iŋ?
 who.PL PFV.NSV Bol.GEN PL see
 ‘Who all did Bol see?’ [Van Urk and Richards 2015:127, ex. (23b)]

- b. Kêek áa-c̄i Áyèn ké t̄iŋ.
 them 3PL-PFV.OV Ayen.GEN PL see.NF
 ‘Them, Ayen has seen.’ [Van Urk 2018:947, ex. (19c)]

- The marker *ké* is restricted to the vP region—it cannot appear in C or [Spec,CP]. Furthermore, *ké* is ϕ -sensitive in that it only appears if the moving element is plural, as (16) demonstrates, where the corresponding 3sg element *yé(en)* may not occur and *ké* would also be ungrammatical.

(16) *Singular DPs do not trigger a corresponding SG marker*

- Yè ñà [CP c̄i Ból [vP (*yé(en)) t̄iŋ]]?
 be.3SG who PFV.OV Bol.GEN 3SG see.NF
 ‘Who has Bol seen?’ [Van Urk 2018:940–941, ex. (5a,b)]

- The appearance of *ké* exhibits the hallmark property of successive cyclicity: it appears in every clause that is crossed by movement, as (17) illustrates.

(17) *ké* appears in every clause crossed by movement

Yeyínà yé ké tàak, [_{CP} cǐ Ból ké t̃ɪŋ]?
who.PL HAB.2SG PL think PFV.NSV Bol.GEN PL see

‘Who all do you think Bol saw?’ [Van Urk and Richards 2015:128, ex. (25b), (26a–c)]

- There is furthermore a subject-object asymmetry in that A-bar-extraction of a local subject does not lead to *ké*, as (18) shows. But in crossclausal A-bar-extraction of a plural subject, *ké* appears in higher clauses, as in (19).

(18) \bar{A} -movement of local subject does not trigger *ké*

Ròòòr áa-cé (*ké) ỵin t̃ɪŋ.
men 3P-PFV PL you see.NF

‘The men have seen you.’ [Van Urk 2018:950, ex. (25a)]

(19) \bar{A} -movement of nonlocal subject triggers *ké* in higher clauses

Ròòòr áa-yùukù ké tàak [_{CP} cǐ (*ké) ỵin t̃ɪŋ].
men 3PL-be.1PL PL think.NF PFV PL you see.NF

‘The men, we think have seen you.’ [Van Urk 2018:950, ex. (26a)]

- Finally, certain adjuncts that contain a plural DP also trigger *ké*. This is shown in (20a,b) for movement of the *ék-ko* ‘(at) which times’ and *tóony kê dú* ‘(with) how many pots’, respectively.

(20) \bar{A} -moved adjunct PPs trigger *ké*

a. Yè thèek-kò [_{CP} b̃jì pèel ké dhuòŋ]?
be times-which FUT.OV knives PL break.NF

‘At which times will the knives break?’ [Van Urk 2015:168, ex. (81)]

b. Yè tóony kê díi [_{CP} cǐ Ból ké cụj̣in tháal]?
be pots QUANT.PL how PFV.OV Bol.GEN PL food cook.NF

‘How many pots has Bol cooked food with?’ [Van Urk 2015:169, ex. (83b)]

- In a nutshell, Van Urk (2015, 2018) and Van Urk and Richards (2015) propose that *ké* is the realization of an intermediate copy in [Spec,vP], and they conclude that vP must therefore be a phase. Abstracting away from the details of the implementation, they treat the preverbal object position as [Spec,vP], as already mentioned. Because v has an EPP requirement, this position must be filled if an object exists. Due to vP’s phasehood, an element that is to be moved out of the vP must first move to this [Spec,vP], from where it can then continue to move to [Spec,CP]. If it is plural, this intermediate copy in [Spec,vP] is then realized as *ké*. Because of vP’s phasehood, movement through [Spec,vP]—and hence *ké*—is required in every clause crossed by movement.
- At the same time, the analysis faces several complications. The first complication is that A-bar extraction of a local external argument does not lead to *ké* (see (18)). All else being equal, this is surprising given that external arguments are typically taken to be base-generated in [Spec,vP]. As a consequence, they too should leave a copy in [Spec,vP], which we would then expect to be realized as *ké*, contrary to fact.

- One is that the external argument is not actually base-generated in [Spec,vP], but in a higher specifier. In this case, it is no longer evident that the Dinka data provide evidence for vP phases, at least if by “vP” we mean the projection that generates the external argument, as is standard.
- The other analysis suggested by Van Urk is that only copies of elements that appear in [Spec,vP] as a result of attraction by (i.e., Agree with) v are realized as *ké*. This analysis raises the question how the morphological realization of a copy in [Spec,vP] can be conditioned by whether Merge of this copy was the result of attraction by v or not.
- A second complication concerns the status of unaccusative vP. In Dinka, A-bar-extraction of an internal argument of an unaccusative verb does not lead to *ké*, as shown in (21), where movement of *p̣ɛɛl-kó* ‘which knives’ does not leave a *ké*.

(21) *Argument movement out of unaccusative vP does not strand ké*

Yè [CP p̣ɛɛl-kó ḅɛ̣ [vP (*ké) dhuôŋ]]?
 be knives-which FUT PL break.NF

‘Which knives will break?’

[Coppe van Urk, p.c.]

- At first glance, this restriction might be taken to indicate that unaccusative vP is not a phase and hence that there is no intermediate copy in [Spec,vP] (Chomsky 2000, 2001). However, A-bar-extraction of a PP adjunct out of such vPs does lead to *ké*, as (22) demonstrates, where movement of the *ɛk-kó* ‘which times’ strands *ké*.

(22) *PP-adjunct movement out of unaccusative vP strands ké*

Yè [CP tḥɛ̣ɛk-kó ḅjị p̣ɛ̣ɛl [vP ké dhuôŋ]]?
 be times-which FUT.OV knives PL break.NF

‘At which times will the knives break?’

[Van Urk 2015:168, ex. (81)]

- Van Urk (2018) sketches two possible approaches to the latter generalization: either (i) the external argument is generated outside of vP or (ii) only copies in [Spec,vP] that are the result of movement are realized as *ké*. Neither account generalizes to the fact that unaccusative subjects also do not strand *ké* because they are clearly generated vP-internally and move to [Spec,vP]. Further stipulations are therefore necessary to derive the full distribution of *ké*.
- A third challenge for this account is that *ké* only realizes intermediate copies in [Spec,vP], not intermediate copies in [Spec,CP]. All else being equal, if both CP and vP are phases and intermediate landing sites are created in their respective specifiers, then additional assumptions are again required to prevent the two domains from patterning analogously (Van Urk 2018: 975–976 appeals to impoverishment in CP). This is certainly feasible, but it raises the question why there seem to be no languages that realize lower copies in both CP and vP. If vP is a phase in the same way that CP is, we might expect this to be the default pattern, and yet it appears to be unattested.

3.2 meN-deletion in Indonesian

- A second influential argument for vP phases that we will reconsider here comes from Standard Indonesian and a dialect of Malay used by educated speakers in Singapore.

The basic pattern is that the active voice prefix *meN-* is obligatorily deleted if a DP other than the local subject undergoes A-movement over it (Saddy 1991, Cole and Hermon 1998, Soh 1998, Fortin 2006, Aldridge 2008b, Cole et al. 2008, Sato 2012, Georgi 2014, Jeoung 2018). Aldridge (2008b), Cole et al. (2008), Sato (2012), Georgi (2014), and Jeoung (2018) all interpret this pattern as evidence for vP phases. While their respective accounts differ substantially, the guiding analytical intuition is that any nonlocal subject DP must move to the phase edge of v on its way to [Spec,CP], and this movement to [Spec,vP] bleeds *meN-*.

- The baseline example is (50a). Crucially, when a DP other than the local subject undergoes A-movement, *meN-* is obligatorily deleted, as illustrated with object movement in (50b). If the local subject undergoes movement, *meN-* does not need to delete (50c).

- (50) a. *Baseline*
 Ali telah (**mem-**)baca buku itu.
 Ali PFV MEN- read book the
 'Ali has read the book.' [Soh 1998:296, ex. (1), (6)]
- b. *Object extraction*
Apa-kah₁ yang Ali telah (***mem-**)baca ___₁?
 what-Q that Ali PFV MEN- read
 'What has Ali read?' [Soh 1998:297, ex. (9b,c)]
- c. *Subject extraction*
Apa-kah₁ yang ___₁ telah (**mem-**)baca buku itu?
 who-Q that PFV MEN- read book the
 'Who has read the book?' [Soh 1998:296, 297, ex. (4a), (9a)]

- In constructions with two DP objects, A-bar-movement of either bleeds *meN-*.

- (51) *Ā-movement in ditransitive constructions*
- a. **Apa**₁ yang kamu (***mem-**)beli-kan ibu-mu ___₁?
 what that you MEN- buy-APPL mother-your
 'What did you buy your mother?' [Sato 2012:43, ex. (18b,c)]
- b. **Siapa**₁ yang kamu (***mem-**)beli-kan ___₁ bunga?
 who that you MEN- buy-APPL flower
 'Who did you buy a flower/flowers?' [Sato 2012:43, ex. (18b,c)]

- If the extraction is long-distance, *meN-* must disappear on every verb that is crossed by it. This is illustrated for long object extraction in (52). For long subject extraction, *meN-* does not need to delete in the lowest clause (in line with (50c)) but in all higher ones, as in (53).

- (52) *Long object extraction*
Siapa-kah₁ yang Ali (***meng-**)anggap [Minah \emptyset -suka ___₁?]
 who-Q that Ali MEN- believe Minah like
 'Who does Ali believe Minah likes?' [Soh 1998:298, ex. (11b,c)]

(53) *Long subject extraction*

Siapa-kah₁ yang Ali (***meng-**)anggap [___₁ **men-yukai** Karim]?
who-Q that Ali MEN- believe MEN- like Karim

'Who does Ali believe likes Karim?'

[Soh 1998:297–298, ex. (11a,d)]

- Notably, A-bar-movement of elements that are not DPs does not have this effect (Cole and Hermon 1998, Soh 1998, Fortin 2006, 2007, Sato 2012). Movement of PPs or adverbs does not induce *meN*-deletion, even if the PP originates within the vP, as shown in (54). If a non-DP undergoes long movement, no *meN*-deletion takes place in either clause, as illustrated in (55).

(54) *Non-DP movement*

a. [**Kepada siapa-kah**]₁ Minah **mem-beri** kucing kesayangannya ___₁?
to who-Q Minah MEN- give cat beloved.her

'To who did Minah give her beloved cat?'

[Soh 1998:313, ex. (32b)]

b. **Kenapa**₁ Mary (**mem-**)beli buku itu ___₁
why Mary MEN- bought book that

'Why did Mary buy that book?'

[Cole and Hermon 1998:231, ex. (26a)]

(55) *Long non-DP movement*

a. [_{CP} [**Kepada siapa**]₁ kamu **meng-harapkan** [_{CP} Ali akan **mem-beri**
to who you MEN- hope Ali FUT MEN- give
mobil+nay ___₁]]?
car+3sg

'To who do you hope Ali will give his car?'

b. [_{CP} **Mengapa** kamu **meng-harapkan** [_{CP} Ali akan **mem-beli** mobil]]?
why you MEN- hope Ali FUT MEN- buy car

'Why do you hope Ali will buy a car?'

[Fortin 2007:51–52, ex. (73), (78)]

- Aldridge (2008b), Cole et al. 2008, Sato (2012), and Georgi (2014) all interpret this pattern as evidence for vP phases. While their respective accounts differ in significant ways, the guiding analytical intuition is that an object DP must move to [Spec,vP] on its way to [Spec,CP], and this movement to [Spec,vP] bleeds *meN*-. Where these accounts differ is how this bleeding effect is implemented.
- Aldridge (2008b) and Sato (2012) propose that v bears a designated feature that attracts an object DP to its edge (EPP for Aldridge 2008b; [+D] for Sato 2012), which then prevents realization of *meN*-. The fact that extraction of non-DPs does not bleed *meN*- is somewhat puzzling under these accounts. If non-DPs must check this feature to reach the vP edge, then they too should block *meN*-, contrary to fact. On the other hand, if they can reach the vP edge without checking this feature, then it is not clear why DPs cannot do so as well. A second obstacle to such an account is why [EPP]/[+D] is not checked by the external argument in [Spec,vP]. This would incorrectly bleed *meN*- even if no object movement takes place.

- Cole et al. (2008) propose that *v* acquires the Case features of all DPs in its specifier(s). Movement of an object to [Spec,vP] leads to an [acc] specification in addition to the [nom] specification contributed by the external argument, which gives rise to a feature conflict, which *meN-* does not tolerate, leading to ungrammaticality. It seems to us that extending this account to long-distance subject extraction such as (53) requires additional assumptions because both specifiers of the higher *v* bear [nom], which does not obviously create a feature conflict.
- Another line of approach is developed by Georgi (2014:151–156), who proposes that *meN-* is bled by an impoverishment rule that is triggered if [Spec,vP] contains a DP with a valued case feature. The fact that only DPs delete *meN-* follows from the formulation of the impoverishment rule. The subject/object asymmetry is captured because the impoverishment applies only if the DP has a valued case feature. Subjects are taken to receive case in [Spec,TP], so that the copy in [Spec,vP] is caseless and hence does not trigger the rule. This analysis appears at odds with the standard view that feature valuation takes place in syntax and impoverishment applies postsyntactically (see Keine 2010 for an alternative view). On this architecture, all features are valued by the time impoverishment applies, and as a result impoverishment cannot distinguish between DPs with valued and unvalued case features. The subject–nonsubject distinction would then be lost.

3.3 *kè-morphology in Defaka*

- Defaka is a SOV language that allows focus fronting of maximally one XP. This fronting has morphological effects. When a local subject is focus-fronted, it bears a focus marker *kò*; the verb morphology remains unaffected. When any element other than the local subject undergoes focus fronting, two reflexes arise. First, the fronted XP bears the focus marker *ndò*. Second, the verb bears the special morphological marker *kè*.

- (69)
- No focus-fronting*
 ì Bòmá ésé-kà-rè
 I Boma see-FUT-NEG
 ‘I will not see Boma.’
 - Local-subject focus*
 ì kò Bòmá ésé-kà-rè
 I FOC.SBJ Boma see-FUT-NEG
 ‘I will not see Boma.’
 - Object focus*
 Bòmá ndò ì ésé-kà-rè-kè
 Boma FOC I see-FUT-NEG-KE
 ‘I will not see Boma.’

[Bennett et al. 2012:294, ex. (1)–(3)]

- Importantly, the split groups local subjects apart from all other fronted elements. That is, fronting of adjuncts patterns like fronting of objects, as shown in (70): the fronted XP bears *ndò*, and the verb bears *kè*. This includes locative adverbs and temporal adverbs.

(70) *Adjunct focus* → *kè*

- a. [*ándù kikià*] *ndò* à *èbèrè rì bòi-mà-kè*
canoe under FOC the dog KE hide-NFUT-KE
'The dog is hiding under the canoe.' [Bennett et al. 2012:296, ex. (15)]
- b. *òmòmò ndò Bòmá ibò tìnà árí-kè*
now FOC Boma big fish catch-KE
'Boma caught a big fish just now.' [Bennett 2009:18, ex. (59b)]
- c. [*nùmá bió*] *ndò* ò à *tìnà árí-kè*
that river FOC he the fish catch-KE
'He caught the fish in that river.' [Bennett 2009:18, ex. (61b)]

- Long focus fronting is possible, and in this case, *kè* arises in the way just described on all verbs crossed by movement. If an object is moved nonlocally, both the embedded verb and the matrix verb bear *kè*, as (71) shows.

(71) *Nonlocal-object focus*

- ándù₁ ndò Bòmá fàà-kè* [_{CP} *ìní* ___₁ *été-kè*]
canoe FOC Boma say-KE they have-KE
'It's a canoe that Boma said that they have.' [Bennett et al. 2012:297, ex. (21)]

- If an embedded subject is fronted nonlocally, *kè* does not appear on the embedded verb, but it must appear on the matrix verb. Additionally, *ndò* must appear in the matrix clause rather than *kò*. This is illustrated in (72).

(72) *Nonlocal-subject focus*

- Bruce₁ ndò/*kò Bòmá jíri-*(kè)* [_{CP} ___₁ *á* *ésé-mà*]
Bruce FOC/*FOC.SBJ Boma know-*(KE) her see-NFUT
'Boma knows (that) Bruce saw her.' [Bennett et al. 2012:297, ex. (18)]

- Bennett (2009) and Bennett et al. (2012) argue that the distribution of *kè* provides evidence for vP phases (also see Van Urk 2016, 2020a,c). They propose that focus extraction of any element that is not located at the vP edge requires it to first move to [Spec,vP] in order to leave the vP phase. *Kè* is then analyzed as reflecting such intermediate movement. Such movement is required for nonsubjects and nonlocal subjects but not for local subjects, which are basegenerated at the vP edge.
- Importantly, however, Bennett (2009) and Bennett et al. (2012) argue that *kè* is not located within the vP but within a higher head (which they dub “X⁰”) that is located between vP and TP. The reason is that movement of the vP does not move *kè* along, as would be expected if *kè* were part of the vP. The authors suggest that *kè* selects for a vP that bears a [+Focus] feature (which attracts an element to its edge). Thus, if v attracts a [+Focus] element to its edge, then the next-higher head is realized as *kè* as schematized in (73).

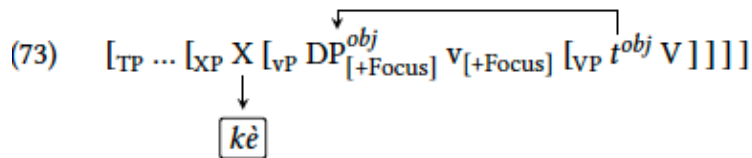

- In order to account for the distribution of *ndò* and *kò*, Bennett (2009) and Bennett et al. (2012) locate these elements in the left periphery. Concretely, they propose that the clausal spine contains one projection that licenses a subject (“SubjP”) and, higher, a FocusP projection. If any element other than the local subject is fronted, this element occupies [Spec,FocusP] while the local subject is located in [Spec,SubjP], as shown in (74). In this case, Focus⁰ is realized as *ndò*.

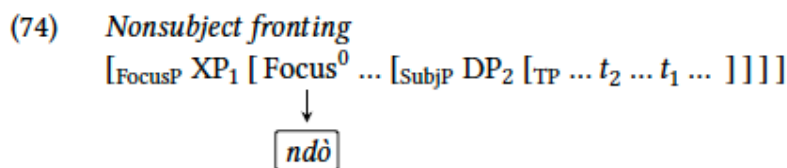

- Building on work by Giorgi and Pianesi (1996), they then propose that if a local subject is focus-fronted, these two projections are combined into a joint {Focus–Subj} projection, whose specifier is occupied by a fronted local subject, as shown in (75). This {Focus–Subj} head is then realized as *kò*. If a joint Focus–Subj projection is possible, it must be used, making *kò* obligatory with local-subject extraction.

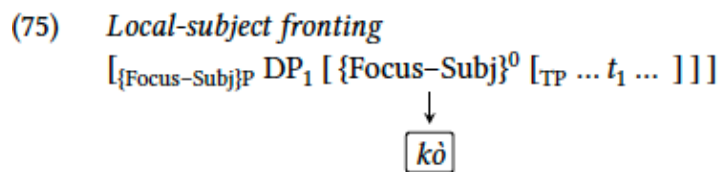

- While this is a tenable analysis of the Defaka facts, it faces a number of concerns, to which we now turn. First, while Bennett (2009) and Bennett et al. (2012) appeal to vP phasehood to derive the distinction between local subjects (which originate at the vP edge) and objects (which must move, hence triggering *kè*), it is not at all clear that this analysis handles adjuncts correctly.
- As shown in (70), adjunct fronting likewise triggers *kè*. On a vP phase account, this would require that all adjuncts are base-generated within the VP and move to [Spec,vP] in order to be extracted to CP. Bennett (2009) and Bennett et al. (2012) do not provide independent support for this claim. The fact that even locative and temporal adverbs—which generally have to be vP-external given their scopal behavior—casts serious doubts on this crucial part of the account: Once adjuncts are brought into the picture, the empirical split between local subjects and everything else does not correlate (under standard views about the position of adjuncts) with the distinction between VP-internal and VP-external material that vP phases give rise to. We take this as an indication that it is not vP that underlies the split.
- In addition, the vP-phase analysis faces a conceptual problem as well. The distribution of *kè* correlates with that of *ndò*, which marks fronted XPs other than local subjects. Despite the fact that the two markers appear under the same conditions, Bennett’s (2009) and Bennett et al.’s (2012) analysis treats them separately: *kè* is analyzed in terms

of vP phases, while *ndò* is attributed to properties of higher functional projections. In light of the similarities in the distribution of *kè* and *ndò*, one should wonder whether it is not possible to analyze *kè* in terms of higher functional projections as well.

4. Alternative analyses

- The different challenges these vP-phase-based accounts for extraction morphology face, call for alternative analyses. In this paper, we argue that all phenomena reduce to the fact that C can only target the closest DP to move into its specifier position. To derive configurations where lower DPs end up in [Spec,CP] at an earlier derivational stage, they need to raise across the subject. Extraction morphology is the reflection of (optional) probes that do so.

4.1 Dinka

- We first consider the obligatory emergence of *ké* under A-extraction if the object of a transitive clause is moved. We broadly agree with analyzing *ké* as a reflex of successive-cyclic movement. Where we differ from Van Urk (2015, 2018) and Van Urk and Richards (2015) is in whether this successive cyclicity is to be analyzed in terms of vP phases. Doing so faces the challenges just mentioned, and more generally calls for an explanation of the various CP–vP asymmetries discussed before. Instead, we explore an account of the Dinka pattern that does without vP phases. We propose that the successive cyclicity that *ké* is a reflex of is instead caused by the restriction in (23).

(23) **Dinka C may only attract the structurally closest DP.**

- Restrictions like (23) have been proposed independently in the recent literature, and they may be implemented in a number of ways. Aldridge (2004, 2008a) proposes a restriction like (23) to account for A-bar-extraction restriction in certain ergative languages. Analogous restriction are proposed and explicitly argued for by Erlewine (2018), Branen and Erlewine (2020), and Coon et al. (2020). We therefore take (23) to be independently motivated. Our goal is to further broaden its scope by assimilating apparent vP-phase effects to this restriction instead.
- The restriction in (23) underlies not only our account of Dinka, but also the accounts of Indonesian and Defaka. In a nutshell, we (23) expresses is a minimality/intervention effect. Because C can only attract the structurally closest DP, any DP that is separated from C by a higher DP cannot be attracted, as schematized in (24a). We suggest that this gives rise to “leapfrogging” (a term due to McGinnis 1998): the lower DP first moves to a position above the higher DP, from which it is then the closest goal to C, enabling movement to [Spec,CP] that conforms with (23), as shown in (24b).

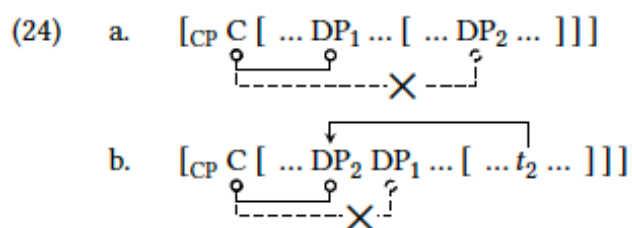

- The key difference between vP phases and (23) is that it is an intervening DP, rather

than the vP, that gives rise to the locality effect. We then analyze *ké* as the reflex of the probe that gives rise to this leapfrogging.

- For the sake of concreteness, we will assume that external arguments do not have to raise to [Spec,TP] in Dinka (see [Cable 2012](#) for arguments that the related Nilotic language Dholuo does not show EPP effects). Leapfrogging must therefore move a DP across the external argument in [Spec,vP]. We propose that this leapfrogging in Dinka is triggered by v, which optionally bears a ϕ -Agree feature [$u\phi$]. This feature triggers movement of the goal to an outer [Spec,vP]. [$u\phi$] agrees with the closest ϕ -bearing element c-commanded by v and attracts this element to an outer [Spec,vP], a position above the base position of the external argument, resulting in leapfrogging. Because *ké* only appears if the moving element is plural, we take it to be the realization of plural agreement with [$u\phi$], as stated in (25).

(25) /*ké*/ ↔ [PL]

- In contrast to [Van Urk \(2015, 2018\)](#) and [Van Urk and Richards \(2015\)](#), we hence do not analyze *ké* as the realization of an intermediate copy, but rather as agreement on v.
- Let us apply this proposal to a configuration in which an object undergoes A-bar-movement, such as (27). The resulting derivation is given in (28). In order for the object to be attractable to C, it must be closer to C than the external argument. v must therefore bear [$u\phi$], enabling leapfrogging and subsequent movement of *yeyínà* ‘who.pl’ to [Spec,CP]. The plural agreement on [$u\phi$] is then realized as *ké*.

(27) **Yeyínà cji Ból ké t̩ŋ?**
 who.PL PFV.NSV Bol.GEN PL see
 ‘Who all did Bol see?’

[[Van Urk and Richards 2015:127, ex. \(23b\)](#)]

(28) Derivation of (27)

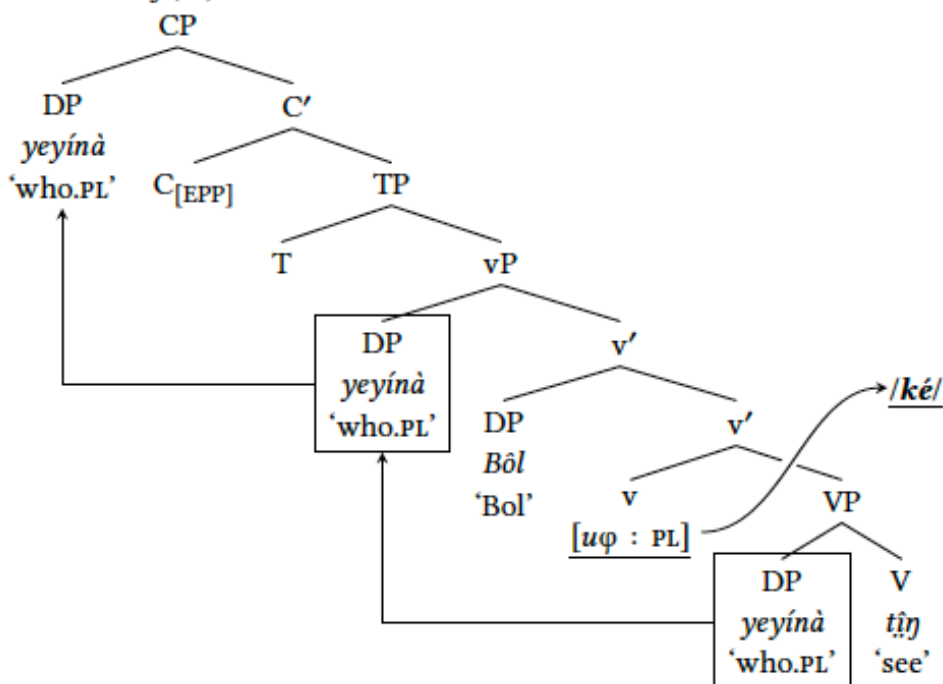

- By contrast, if a local subject is extracted to [Spec,CP], as in (29), no *ké* appears. This is because in order for C to attract the external argument, it must be the closest element to C. This is the case only if no leapfrogging of a lower DP takes place, hence if v does not bear [$u\phi$]. Because *ké* is the realization of [$u\phi$], it follows that no *ké* appears in such configurations.

(29) **Ròòòr** áa-cé (*ké) yîin tîin.
 men 3P-PFV PL you see.NF
 'The men have seen you.'

[Van Urk 2018:950, ex. (25a)]

(30) Derivation of (29)

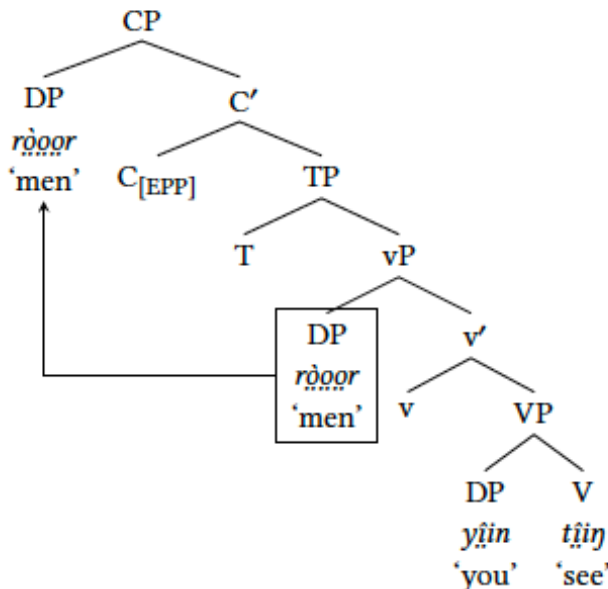

- Note that there is no look ahead: if v bears [$u\phi$], leapfrogging will take place and a DP other than the external argument will move to [Spec,CP]. By contrast, if v does not bear [$u\phi$], no leapfrogging takes place and the external argument moves to [Spec,CP]. The choice of whether to equip v with [$u\phi$] is free, with different consequences for what DP will move to [Spec,CP]. In this way, the analysis derives the basic split between subjects and lower DPs from intervention instead of vP phases.
- Let us turn next to the empty-edge effect. As discussed in section 3.1, such effects appear with ditransitive verbs. Recall that in such constructions, one object must appear before the verb and one following the verb (see (32)). Furthermore, if A-movement of an object out of this vP takes place, it must empty the preverbal position and cannot empty the postverbal position.
- As noted in section 4.1, Van Urk (2015, 2018) and Van Urk and Richards (2015) analyze this restriction in terms of vP phases. On their analysis, v bears an EPP property, requiring one of the two objects to move to [Spec,vP]. Subsequent A-movement can then only target this element, not the VP-internal, postverbal object.
- Interestingly, Van Urk (2015:151–154) argues that [Spec,vP] may only be filled by the structurally closer object and that configurations in which the indirect object appears preverbally are derived from a different base configuration than configurations in which the direct object appears preverbally. In other words, he argues that such constructions

differ in their base structure as shown in (34) and (35), respectively. Whichever object occupies the preverbal position is base-generated as the higher object within the VP.

(34) *Van Urk's (2015:153) structure for (32a)*

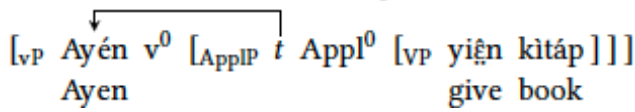

(35) *Van Urk's (2015:154) structure for (32b)*

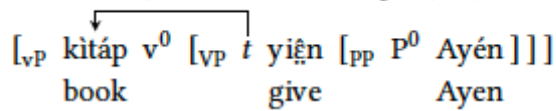

- In these structures, the displacement to [Spec,vP] is string-vacuous, driven only by the assumption that vP is a phase. If we question this assumption, the possibility emerges that in fact no displacement to [Spec,vP] takes place in (34) and (35) and that the two object DPs remain in their base positions.
- Let us suppose so. Let us furthermore suppose that [$u\phi$] on v may only agree with the closest ϕ -bearing element. If v's search space contains two ϕ -bearing DPs, only the higher one may be attracted and hence leapfrog over the external argument. This has the effect that in ditransitive constructions, only the higher object may move to [Spec,CP] (as such movement requires leapfrogging over the external argument). This is schematized in (36), where [$u\phi$] may only attract the higher object *yeŋà* 'who' to the outer [Spec,vP]. This derives the contrast from Van Urk's (2015) structure for ditransitives and relativized minimality in the probing of [$u\phi$].

(36) *Derivation of (33a)*

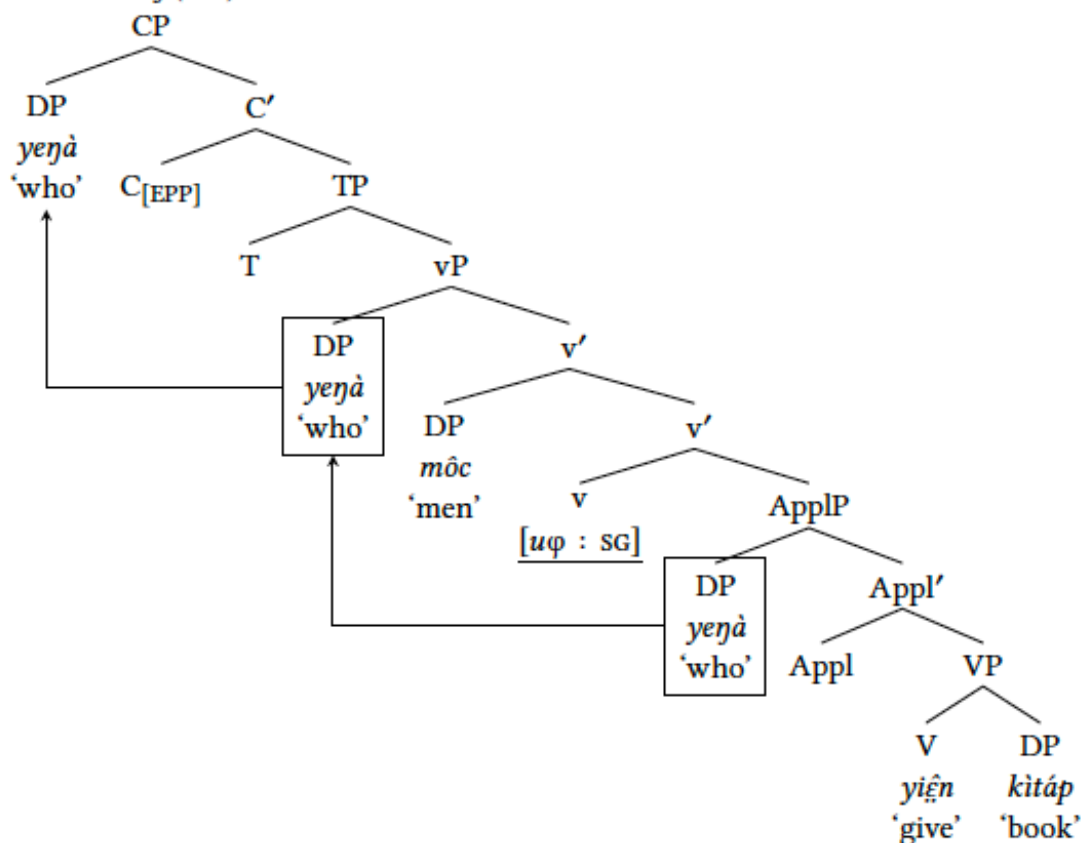

- Our treatment of object extraction in transitive and ditransitive clauses gives rise to a question. Recall that in a transitive structure without movement of the object, the verb follows the object, as shown in (37).

(37) *Yēen cé miir t̩ŋ.*
 I PFV giraffe see
 'I saw a giraffe.'

[Van Urk and Richards 2015:122, ex. (14a)]

- But in a ditransitive structure, the verb is sandwiched between the two objects. We would like to suggest that these word order differences are not the result of movement, but reflect a different linearization of the verb relative to its complement. More specifically, we propose that the standard [Comp,V]–V order in transitives switches to a V–[Comp,V] order in ditransitives.
- We ground this asymmetry in case assignment (or nominal licensing). Stowell (1981) proposes that case assignment is subject to an adjacency condition, such that a case-assigning verb must be directly precede or follow an object that it case-licenses (also see Chomsky 1980, 1981, Janke and Neeleman 2012, Baker 2014, Levin 2015, Belk and Neeleman 2017, Erlewine et al. 2017, Erlewine 2018, and Van Urk 2020b for various alternative proposals of how to implement an adjacency condition on nominal licensing, either involving Case or not). In Dinka ditransitive constructions, both objects bear unmarked absolutive case, the same case as direct objects of transitives. It therefore stands to reason that both objects receive case from the verb. But the adjacency condition on case assignment prevents such case assignment if the word order is OOV or VOO, as stated in (38). The only way for the verb to be adjacent to both objects in order to license them is to be sandwiched between them, hence an OVO word order.

(38) a. *DP_{ABS} DP_{ABS} V
 b. *V DP_{ABS} DP_{ABS}

- One consequence of this account is that it offers a new solution to a puzzle with PP extraction. The puzzle is that PP extraction does not empty the preverbal position. This is illustrated in (42). The element *ye bæe ...i kô* '(to) which villages' is A-bar-moved, resulting in *ké*. Importantly, however, the immediately preverbal position (underlined in (42)) is not emptied but instead occupied by the object DP *w̩n̩m̩áth* 'brother'.

(42) *Ye bæ̩i kô cénnè ny̩n̩k̩ai ké w̩n̩m̩áth tuòc?*
 Q villages which PFV.OBLV sister PL brother send
 'Which villages did my sister send my brother to?'

[Van Urk and Richards 2015:130, ex. (30a)]

- On Van Urk and Richards's (2015) and Van Urk's (2015) account, where the preverbal position is [Spec,vP] and must be targeted by intermediate movement due to vP phasehood, the fact that PPs apparently do not need to pass through this [Spec,vP] is surprising. To account for configurations like (42), Van Urk and Richards (2015) and Van Urk (2015) propose that PPs pass through a second, outer [Spec,vP], which is not available to DPs so that emptying of the inner [Spec,vP] only arises with DP extraction. On the account we propose here, (42) follows without additional assumptions to this

A-bar-probe may be specified not just for an A-bar-feature but also for a categorical feature. We thus assume that C in Indonesian has the makeup in (56) (to be extended below). (56) contains a complex probe that searches for both [*uFoc*] and [*uD*].

(56) C: [*uFoc+uD*]

- Erlewine (2018) and Coon et al. (2020) furthermore argue that complex probes of this type cannot attract a fully-matching goal over a partially matching one (also see Coon and Keine to appear). This restriction is stated in (57) and schematized in (58). In (58), the probe [*uA+uB*] comprises the two segments [*uA*] and [*uB*]. YP contains only a matching feature [*A*], and ZP contains a full [*A+B*] match. It is then not possible for the probe to attract ZP over YP.

(57) A complex probe cannot attract a fully-matching element across a partially-matching element.

(58) * [XP — X_[*uA+uB*] [... YP_[*A*] ... ZP_[*A+B*] ...]]

- Erlewine (2018:686–687) implements (57) at the level of the Agree operation: a complex probe that encounters a partially-matching element stops probing. It therefore the Agree step in (58) that is illicit (and movement is thus impossible to begin with). Coon et al. (2020) derive this result from Coon and Keine’s (to appear) feature-gluttony system, according to which it is the movement step in (58) that is impossible. The choice does not matter for our account here. We will therefore focus on the effects of (57) for Indonesian, rather than on the specific way (57) is implemented.
- If the [*uFoc*]-bearing element is the external argument, no question of intervention arises. But if it is a lower DP that bears [*uFoc*], the external argument intervenes. As in Dinka, this intervention results in the need for leapfrogging. For the sake of concreteness, we will treat this leapfrogging as being triggered by an optional, noncriterial [*uFoc*] feature on v.¹⁴ We then analyze *meN*-deletion as a reflex of [*uFoc*] on v. Adapting Georgi’s (2014) account, we treat *meN*- as an active voice marker and appeal to the impoverishment rule in (60), which deletes active voice in the context of [*uFoc*].

(59) /*meN*-/ ↔ [VOICE: ACT]

(60) [VOICE: ACT] → ∅ / ___ [*uFoc*]

- In the case of subject A-bar-movement, no leapfrogging must take place, as schematized in (61). Assuming that the distribution of [*uFoc*] on v is subject to economy (following the Dinka analysis) and that [*uFoc*] is only present when it enables leapfrogging, v lacks [*uFoc*] in (61). The condition for (60) is hence not met, and no *meN*-deletion takes place.

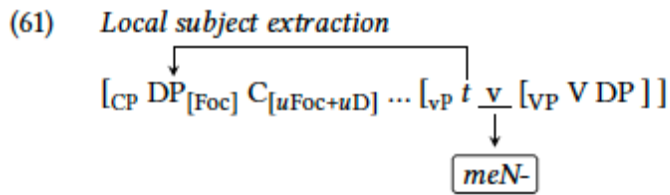

- Turning now to A-movement of an object DP, C cannot attract such an object across the external argument due to (57). The object must hence first leapfrog over the external argument, requiring the presence of [uFoc] on v. Application of (60) is therefore obligatory, leading to obligatory deletion of *meN-*, as shown in (62).

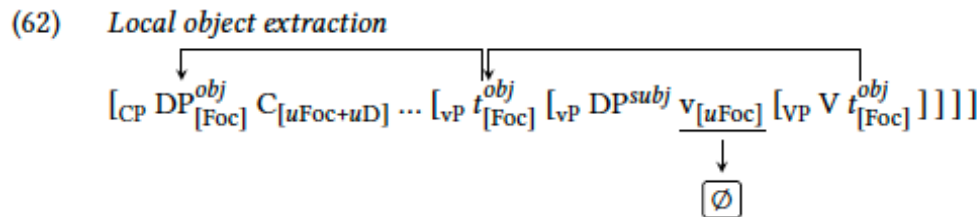

- Long-distance DP extraction proceeds analogously. In order for the embedded argument to be attractable by matrix C, it must first leapfrog around the external argument of the matrix clause, requiring matrix v to bear [uFoc] and hence bleeding *meN-* in the matrix clause.
- Let us now turn to extraction of non-DPs. Here, our account diverges from vP phase accounts in a particularly clear way. Recall that A-bar extraction of PPs and adverbs does not lead to obligatory *meN-* deletion even if the element clearly originates within the vP. A relevant example is repeated in (63). Here, local extraction of a PP object does not delete *meN-*.

(63) [Kepada siapa-kah]₁ Minah mem-beri kucing kesayangannya ___₁?
 to who-Q Minah MEN- give cat beloved.her
 'To who did Minah give her beloved cat?' [Soh 1998:313, ex. (32b)]

- Let us take (63) at face value: if obligatory *meN-* deletion is a reflex of successive-cyclic movement through vP, then the fact that it does not apply in (63) suggests that the movement in (63) does not proceed through vP. Such an analysis is of course impossible if vP constitutes a phase, but it becomes available on the intervention/minimality account we propose here. Broadly speaking, our suggestion is that for C in Indonesian, minimality is assessed on a categorial level: if C attracts a DP, it must be the closest DP; if C attracts a PP, it must be the closest PP, etc. To derive this behavior, we postulate that (56) is not the only possible featural makeup for C in Indonesian. C's specification is not limited to [uFoc+uD] (which would limit A-extraction to DPs), but can also take the form in (64b) and (64c).

- (64) a. C: [uFoc+uD] (= (56))
 b. C: [uFoc+uP]
 c. C: [uFoc+uAdv]

- (64b) and (64c) attract focused PPs and adverbs, respectively. Importantly, nonfocused DPs do not constitute a partial match to either (64b) or (64c). Such DPs therefore do not

cause an intervention effect. This has the crucial consequence that PPs and adverbs do not need to leapfrog over the external argument, which is invariably a DP. PPs and adverbs may therefore move to [Spec,CP] in one-fell-swoop, explaining why no *meN*-deletion takes place in such cases. This contrast is illustrated for DP extraction and PP extraction in (65). As (65a) shows, the external argument constitutes a partial match to C[uFoc+uD], hence requiring leapfrogging and *meN*-deletion. By contrast, PP extraction requires C[uFoc+uP]. Because the external argument is not a partial match to this probe, the PP may be attracted to C directly. Leapfrogging and *meN*-deletion do not apply.

(65) a. *One-fell-swoop extraction of a lower DP impossible*

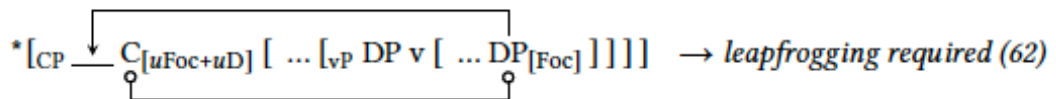

b. *PP-extraction possible without leapfrogging*

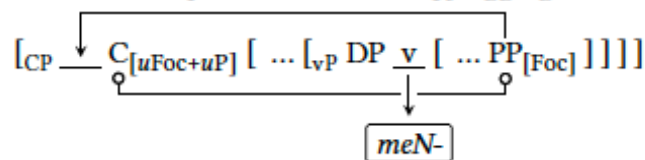

- This account offers a new perspective on why *meN*-deletion arises only with DP extraction. Because the external argument is always a DP, it causes intervention only for DP attraction by C, not for attraction of other categories. The DP/non-DP asymmetry is thus derived from category-based intervention and the fact that external arguments are DPs. This line of explanation is not available on a vP-phase account. On such an account, all extraction must pass through [Spec,vP], and it is therefore necessary to encode in some other way that only DPs in [Spec,vP] have this effect but PPs and adverbs do not. Dispensing with vP phases hence paves the way for a tighter connection between *meN*-deletion and successive cyclicity through vP: *meN*-deletion is obligatory if and only if movement passes through [Spec,vP].
- A prediction that now emerges from the intervention account is that even DP movement should not bleed *meN*- if there is no external argument and so no leapfrogging is necessary. This prediction seems to be borne out. As discussed by Sato (2012), Georgi (2014), Jeoung (2018), it is possible for *meN*- to mark intransitive verbs, including unaccusative verbs. An example is provided in (66). Jeoung (2018:81) provides several examples of intransitive verbs that may Why does *meN*- not need to delete in (66)? If the DP passed through [Spec,vP] on its way to [Spec,TP], we would expect obligatory *meN*-deletion. This suggests that the structure is as in (67).

(67) *Unaccusative structure*

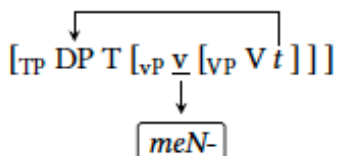

4.3 Defaka

- The analysis we develop preserves Bennett's (2009) and Bennett et al.'s (2012) key idea that the distribution of *ndò* and *kò* is conditioned by whether the projection that hosts

the subject and the Focus projection are conflated into a single projection or not. But we show that this line of analysis can be extended to *kè*, thus obviating the need to additionally appeal to vP phases.

- For the sake of concreteness, let us assume a simple CP > TP > vP > VP clause structure, as before. C is responsible for focus-fronting an XP, and in line with our accounts of Dinka and Indonesian, C may only attract the closest DP.
- Furthermore, we assume with Bennett (2009) and Bennett et al. (2012) that the subject raises to a vP-external position in Defaka, which we identify as [Spec,TP]. As a result, if a nonsubject is to be A-bar-extracted, it must first move to an outer specifier of TP in order to be attractable by C.
- We also follow Bennett (2009) and Bennett et al. (2012) in the assumption that if T and C would have the same element in their specifiers, they are conflated into a single {C–T} projection that comprises the features of both T and C.
- Against this background, we propose that *ndò* and *kò* are the realization of C and that *kè* is the realization of T. Their precise specifications are given in (76).

- (76)
- a. /ndò/ ↔ C_[uFoc] / [CP XP __
 - b. /kò/ ↔ {C–T}_[uFoc] / [C–TP XP __
 - c. /kè/ ↔ T_[uFoc]

- As in our analyses of Dinka and Indonesian, we assume that C in Defaka may only attract the closest element, even if this element is not focused. Because fronting is associated with a focus interpretation in Defaka, we broadly adopt the analysis of Indonesian, according to which C bears a complex probe. Unlike Indonesian, however, intervention is not category-specific in Defaka. Fronting of PPs and adverbs requires *kè* and hence leapfrogging. We therefore propose the complex probe in (77).

(77) C: [uFoc+EPP]

- Let us consider a number of specific configurations. We begin with local-object A-movement, illustrated in (78). In this configuration, the object bears a [Foc] feature. After the subject A-moves to [Spec,TP] (Bennett 2009, Bennett et al. 2012), it intervenes between C and the focused object. The complex probe (77) can therefore not attract the object from its position. Object extraction thus requires leapfrogging of the object to an outer [Spec,TP] above the subject, triggered by [uFoc] on T. C can then attract the object to [Spec,CP] because the object matches both [EPP] and [uFoc]. Given the items in (76), the derivation in (78) results in T being realized as *kè* and C as *ndò*.

(78) Local-object fronting

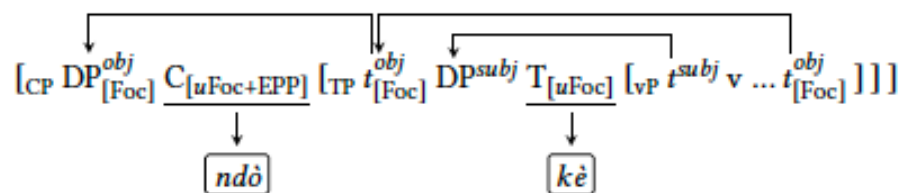

- Next, consider A-bar-fronting of a local subject, schematized in (79). Following the

proposal in Bennett (2009) and Bennett et al. (2012), in this case C and T are conflated into a single {C–T} head that subsumes the featural content of both C and T. Movement of the focused subject to [Spec, {C–T}P] simultaneously satisfies T’s EPP requirement and C’s [uFoc+EPP].²³ In line with the items in (76), the {C–T} head is realized by *kò*.

(79) *Local-subject fronting*

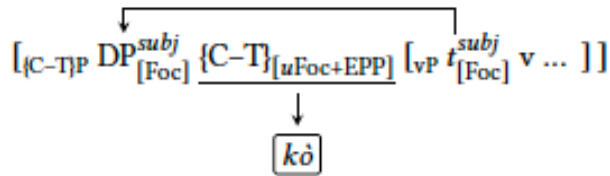

- Third, let us consider a configuration in which an adjunct to TP is A-bar-extracted, such as the temporal adverb in (70b). The structure is schematized in (80). If the to-be-focused adjunct is base-generated below T, [uFoc] on T attracts the adjunct to an outer [Spec,TP], leading to *kè*, as above. If the adjunct is base-generated in an outer [Spec,TP], [uFoc] on T agrees with the adjunct in its base position, either as an instance of Spec–Head agreement (Mahajan 1989, Chomsky 1991, 1993), cyclic Agree (Rezac 2003, 2004, Béjar and Rezac 2009), or Upward Agree (Zeijlstra 2012, Carstens 2016, Bjorkman and Zeijlstra 2019). The adverb then undergoes focus movement to [Spec,CP]. As a result, T is realized as *kè*, and C is realized as *ndò*.

(80) *TP-adverb fronting*

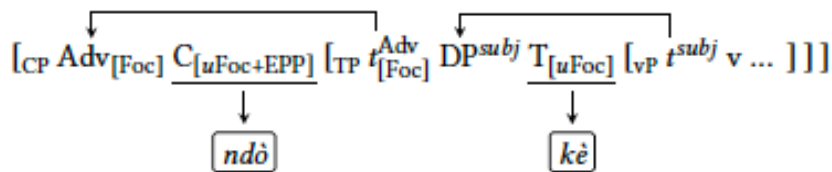

- Next, let us turn to long-distance movement of an object. Such movement results in *kè* in every clause that is crossed by movement and in *ndò* in the clause that hosts the criterial position of the moved DP. The relevant structure is given in (81). Because CP is a phase, extraction out of the embedded clause must proceed through [Spec,CP], which we assume is triggered by a noncriterial counterpart of (77) on the intermediate C. As in the previous cases, the [Foc]-bearing object is attracted by the embedded T, leading to leapfrogging over the subject. After subsequent movement to the embedded [Spec,CP], the object is then attracted by the matrix T’s [uFoc], from where it is then attractable by the matrix C. Because both clauses hence contain a T with a checked [uFoc] feature, *kè* appears in both. By contrast, *ndò* appears only in the matrix clause because [uFoc] on the intermediate C is not in the context of an overt element in [Spec,CP], and insertion of *ndò* is therefore not licensed

(81) *Nonlocal-object fronting*

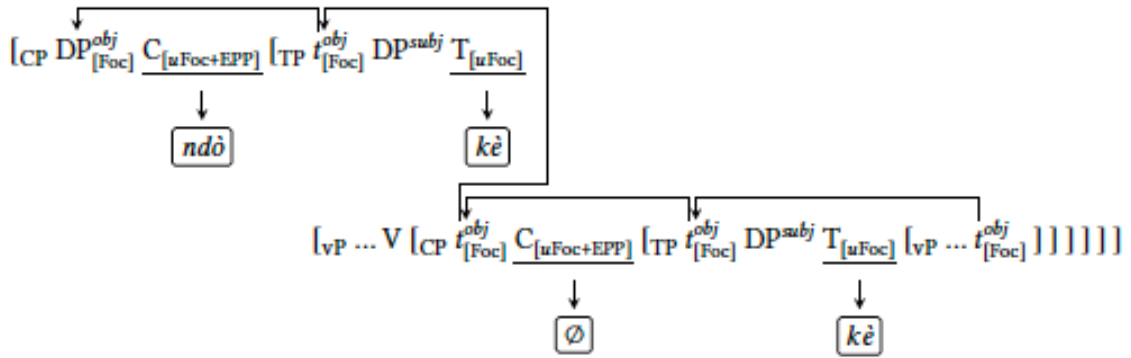

- Finally, this account also handles nonlocal-subject extraction (see (72) for an example). In this case, the fronted embedded subject bears *ndò*, and *kè* appears on the matrix verb but not the embedded verb. The corresponding structure is given in (82). Due to CP phasehood, the embedded subject must first move to the edge of the embedded clause. Just as in (79), the embedded CP and TP are conflated into a single projection, which attracts the external argument to its specifier. From this position, the embedded subject must then move to an outer matrix [Spec,TP] in order to be attractable by the matrix C (due to intervention by the matrix subject DP). It hence agrees with T's [uFoc], followed by Agree with matrix C. In line with (76), the matrix C is realized as *ndò*, the matrix T as *kè*, and the embedded {C–T} as \emptyset because it is not in the context of an overt specifier.

(82) *Nonlocal-subject fronting*

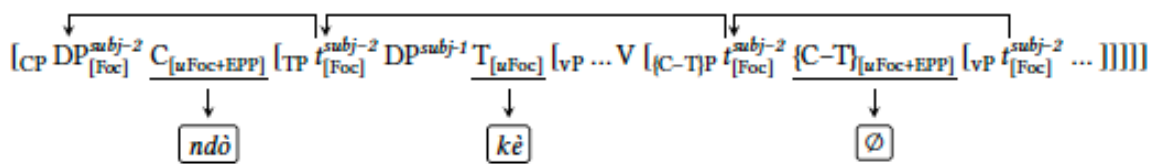

5. Conclusions

- What we have arrived at, then, was a puzzle: why is it that only CPs constitute locality domains for these processes?
- We have proposed that the simplest and most principled explanation emerges if we take these asymmetries at face value: CPs are phases, but vPs are not. The locality asymmetries then receive a principled explanation.
- If vP is not a phase, then previous arguments in favor of it being phasal call for reanalysis. The central goal of this paper was to reassess various arguments that have been made in the literature in favor of vP phases and develop alternative analyses that do not invoke vP phasehood. We focused in particular on arguments that are based on morphological reflexes as several other arguments only show that it is possible to pass through [Spec,vP], a conclusion that is largely independent of the question whether vP is a phase.
- We noted that such reflexes need to be accompanied by a subject–nonsubject asymmetry to clearly implicate regions of the clause lower than C. We investigated in detail three case studies that meet these requirements, and we proposed counteranalyses

that do not involve vP phases. These counteranalyses share with vP-phase accounts that such elements must move through a clause-internal intermediate landing site (though not necessarily in vP). The crucial difference is that the need for this intermediate landing site is not caused by vP phases but rather by minimality: C may only attract the closest element, all else equal the external argument or subject. In order for another element to be attracted to C, this element must first leapfrog around the highest DP. This leapfrogging then manifests itself morphologically.

- Importantly, the limitation that C in some cases may only attract the closest element has been independently motivated in the recent literature to account for effects unrelated to extraction morphology (or vP phases) and it follows from general principles that govern the behavior of complex probes.